

Laboratory Meters

Knick >

The Laboratory pH Meter with uncompromising ease of use.

766 Laboratory pH Meter



The 766 Laboratory pH Meter is designed for standard applications in everyday lab routines. It combines practical functionality and easy operation with comprehensive safety functions.

Gaincheck

Gaincheck performs a complete instrument check. At a keystroke, it not only checks electrical characteristics, but also display and keypad. At power-on, a short check automatically tests device functions. This ensures the device operability, as part of quality management to ISO 9000 and GLP.

Sensoface

checks the electrode and provides information on the electrode condition. Zero point, slope, response time, and glass impedance of the electrode are evaluated.

Trueline

delivers a calibrated analog recorder signal, of course electrically isolated. This provides you with a true pH signal, calibrated for the electrode and without disturbing quantizing levels, permitting undistorted recording of pH curves.

Calimatic

automatically recognizes the right buffer. It allows calibration at the stroke of a key, providing ease of use and – above all – safety. You simply immerse the electrode in two buffers of the selected set, no matter which one you take first, and press the cal key. The meter automatically recognizes the buffer and calibrates itself. It does not matter which buffer solution is taken first.

EMC

EMC design protects the meter from electromagnetic interferences, ensuring reliable measurement results even under unfavorable conditions.

Easy operation with five keys

Even with its comprehensive safety functions, the Model 766 remains easy to operate. Just five keys give access to all functions you require for easy and precise routine measurements.

Temperature compensation manual or automatic

Temperature is automatically compensated. A pH/Pt 1000 electrode detects the temperature and the Model 766 automatically calculates it into the measured value. Of course, you can also measure the temperature using

a separate sensor or enter it manually.

Easy-to-read LED display for pH and temperature

The large, bright 14-segment LED display for alphanumeric characters allows simultaneous readout of pH/mV and temperature.

Safe and robust enclosure

The well-designed enclosure has proved successful in practical use. A waterproof membrane keyboard and drain grooves protect the meter from moisture. The robust, stainless steel covered enclosure resists even strong mechanical stress.

Warranty
3 years!

Defects occurring within 3 years from delivery date shall be remedied free of charge at our plant (carriage and insurance paid by sender).
Sensors and accessories: 1 year

pH/ORP measurement

Isolation Amplifiers
Transmitters

Indicators

Process Analytics

Portable Meters

Laboratory Meters

Sensors

Fittings



Knick >

■ The facts

Gaincheck automatic device test

Trueline calibrated analog
recorder output

Electrode monitoring with
Sensoface icons

Automatic calibration with
patented Calimatic

EMC to NAMUR

Simultaneous pH and tempera-
ture display

Easy operation

Liquid-proof membrane keypad

Robust enclosure

IP 54 protection

3-year warranty

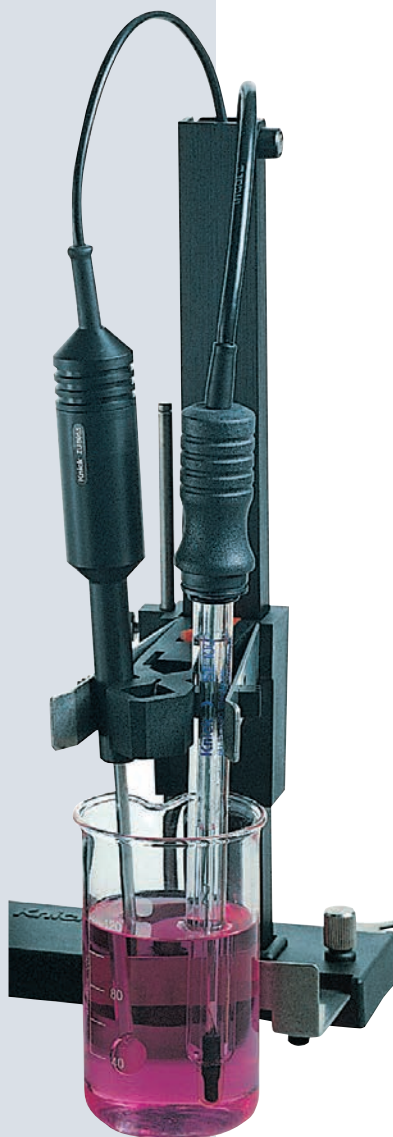

Laboratory Meters

766 Laboratory pH Meter

■ Keypad

On/off
(standby)

Activate
calibration

Exit function and
return to measuring
mode

Activate
diagnostics

Step through or
edit value



■ Gaincheck device self-test

For the self test, the measuring circuit is connected to the recorder output.

The microcontroller sends defined voltage steps to the recorder output. These are measured with the measuring circuit and the A/D converter

and compared with a highly accurate reference voltage. This ensures reliable checking of the signal path. In addition, the Model 766 tests all Sensoface criteria, all memories, the display, and the keypad.

Gaincheck allows you to check your instrument's operability for quality management to ISO 9000 and GLP.

Gaincheck is only available from Knick.

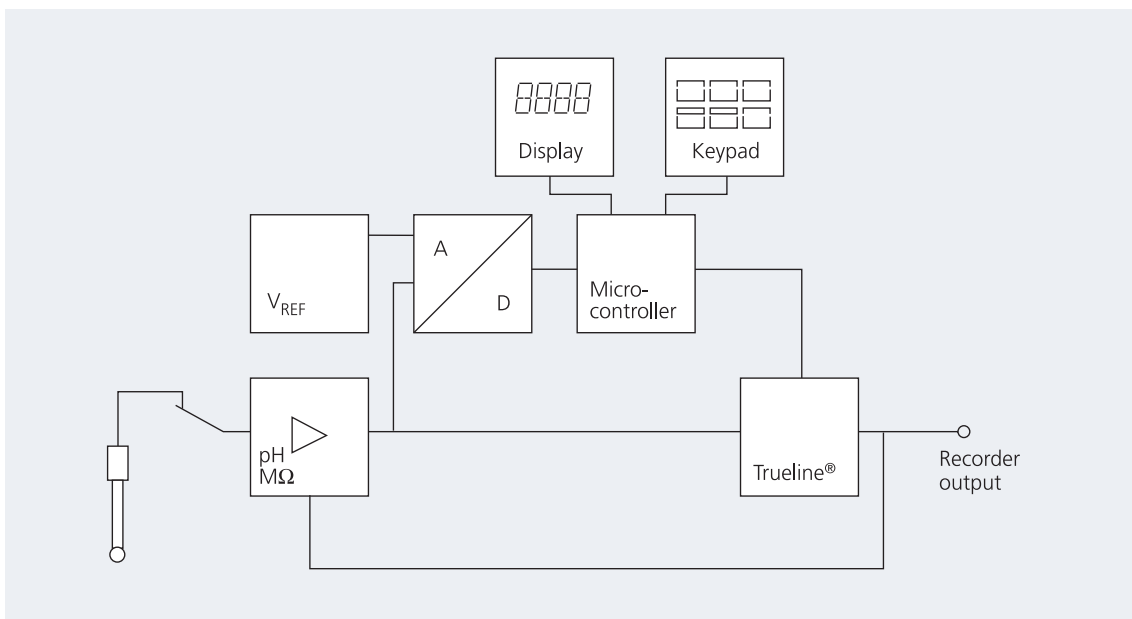

766 Laboratory pH Meter



■ Specifications

Laboratory pH Meter 766

Equipment	Meter with power cord, without electrode
Ranges	pH: -2.00 ... +16.00 / mV: -1999 ... +1999 / °C: -50.0 ... +150.0
Display	Alphanumeric 2 x 4 digits, 14-segment LED, character height 13 mm; Measurement symbols pH/mV/°C/man, 3 Sensoface icons inform on the condition of electrode and measuring equipment (GLP) ³⁾
Measuring cycle	Approx. 1.5/sec
Accuracy ¹⁾	pH: <0.01 / mV: <0.1 % ±0.3 mV / °C: <0.3 K
Input	DIN 19262
Input resistance	>1 x 10 ¹² Ohm
Input current (20 °C) ²⁾	< 1 x 10 ⁻¹² A
Temperature coefficient	<0.1 count/K
Electrode standardization	Calimatic automatic calibration and buffer recognition (German patent 29 37 227), For buffer sets, see Page 76, permitted calibration ranges: Zero: pH 6 ... 8 Slope: 47 ... 61 mV/pH (25 °C)
Electrode monitoring	Sensoface evaluates zero, slope, response time, and glass impedance of the electrode, electrode condition displayed as good / average / poor, can be disabled
Device self-test Gaincheck	Displays all Sensoface criteria and electrode data, tests measurement electronics including memories, measured value processing, and recorder output, checks display and keypad during diagnostics, automatic short check at power-on
Temperature compensation	Pt 1000, automatic selection Manual: 0.0 ... +100.0 °C ^{*)}
Recorder output ^{*)} Truline	pH-compensated, no quantizing levels mV: 1 mV/mV pH: 100 mV/pH Automatic matching to measured value setting
Calibration data storage	Automatic storage of calibration data and settings, self-contained
Data retention	>10 years (EEPROM)
Recorder output ^{*)}	Galvanically isolated mV: 1 mV/mV / pH: 100 mV/pH / °C: 10 mV/°C
Protection against electrical shock	Protective separation of all extra-low-voltage circuits against power supply to DIN VDE 0100 Part 410 as defined in DIN VDE 0106 Part 101 and according to EN 61010 Part 1

^{*)} User defined ¹⁾ ±1 count ²⁾ 45 °C: factor 10 ³⁾ Good Laboratory Practice

Laboratory Meters

766 Laboratory pH Meter

■ Specifications

continued – **Laboratory pH Meter 766**

EMC directive	89/336/EEC
Standards	EN 61326 VDE 0843 Part 20: 2002-3
Ambient temperature	0 ... +45 °C
Storage and transport temp	-20 ... +70 °C
Power supply	230 V –15 % +10 %, 48 ... 62 Hz, <10 VA, Option 363: 115 V AC
Sensor connection	The meter allows connection of any commercial electrodes with DIN plug or banana plug
Enclosure	Glass-reinforced polyamide 12, stainless steel cover, IP 54 protection, prepared for connecting ZU 6954 attachable stand
Dimensions (W x H x D)	244 x 95 x 255 mm
Weight	Approx. 2 kg

Buffer sets

Buffer set – 00 –	Knick technical buffers, nominals 25 °C: 2.00/4.01/7.00/9.21
Buffer set – 01 –	Mettler-Toledo (Ingold) technical buffers, nominal values 25 °C: 2.00/4.01/7.00/9.21
Buffer set – 02 –	Merck, Riedel, nominal values 20 °C: 2.00/4.00/7.00/9.00/12.00
Buffer set – 03 –	Techn. buffer solutions to DIN 19 267, nom. values 25 °C: 1.09/3.06/4.65/6.79/9.23/12.75
Buffer set – 04 –	DIN 19 266 and NIST (NBS), nominal values 25 °C: 1.679/4.006/6.865/9.180/12.454
Buffer set – 05 –	Merck, Riedel, nominal values 20 °C: 1.00/3.00/6.00/8.00/10.00/13.00
Buffer set – 06 –	Merck, nominal values 20 °C: 4.66/6.88/9.22
Buffer set – 07 –	Ciba (94), nominal values: 2.06/4.00/7.00/10.00
Buffer set – 10 –	Mettler-Toledo (USA), nominal values 25 °C: 4.00/7.00/10.01

■ Specifications Accessories

Stand

Order No.: ZU 6954

Material

Pillar: anodized aluminum; carriage and base: polyamide 12 glass reinforced;
Beaker stop, vertical stop, and electrode clasp: stainless steel

Carriage stroke

190 mm

Clamping possibilities Stop for sample beakers

2 x 12 ±0.5 mm; 1 x 4 ... 14 mm; 1 x 6 ... 16 mm
from Ø 30 ... 150 mm

Beaker height

Up to 130 mm

Dimensions (W x H x D)

130 x 300 x 145 mm

Weight

Approx. 410 g

Plug-in power pack for immersion stirrer

Order No.: ZU 6956

Power supply

230 V AC -15 % +6 % <8 VA

Cable length

2 m

Weight

Approx. 380 g

Immersion stirrer

Order No.: ZU 6955

Material

Enclosure: PVC; impeller and shaft: stainless steel

Dimensions

Unit: 250 x Ø 25/12 mm; impeller: Ø 12 mm; immersion depth: approx. 90 mm

Weight

Approx. 140 g

Laboratory Meters

Combination pH electrodes for lab and field units

The SE 100 N and SE 103 N electrodes with a glass body are combination electrodes for standard applications in the lab. The Model SE 100 N has an integrated Pt 1000 temperature probe. The Model SE 103 N with its high-temperature dissipation system is suitable for measurements in media up to 100 °C.

For use in rougher environments, Knick offers the SE 101 N electrode with plastic body. It is also equipped with an integrated Pt 1000 temperature probe. In addition, Knick also offers the SE 104 N puncture electrode. This thin, gel-filled combination electrode is particularly robust and insensitive to pollution. Therefore, it is suited especially for measurements in semi-solid substances such as meat or cheese.



A special feature of the SE 106 N electrode is its ground diaphragm, which achieves a comparatively large, continuous electrolyte flow. The electrode is a good choice when it comes to prevent junction blocking by solids or proteins, minimize charge effects caused by surfactants or dispersions, for example, or measuring in low-ion solutions. The electrode can also be used in high-temperature and/or high-pH solutions.

■ Specifications Combination pH electrodes

Combination pH Electrodes	SE 100 N	SE 101 N	SE 103 N	SE 104 N	SE 106 N
Temperature probe	Pt 1000	Pt 1000	–	–	Pt 1000
Body material	Glass	Plastic (Noryl/PPO)	Glass	Plastic (Noryl/PPO)	Glass
Body length	170 mm	120 mm	170 mm	65 / 25 mm	165 mm
Body diameter	12 mm	12 mm	12 mm	15 / 5 mm	12 mm
Junction	Ceramic	Fibre junction	Ceramic	Open junction	Ground joint
Electrolyte	3 mol/l KCl, refillable	Gel	3 mol/l KCl, refillable	Polymer	3 mol/l KCl, refillable
pH measurement range	0 ... 14	0 ... 14	0 ... 14	2 ... 13	0 ... 14
Temperature range	–5 ... 100 °C	–5 ... 80 °C	–5 ... 100 °C	–5 ... 80 °C	0 ... 100 °C
Recommended temperature probe	Integrated	Integrated	ZU 6959	ZU 0156	Integrated
Remarks	–	–	High-temperature dissipation system	Puncture electrode	High-temperature dissipation system



■ Product line Laboratory pH meters and combination pH electrodes



	766 Laboratory pH Meter Order No.	Unit with power cord, without electrode	766
	Set A	766 Laboratory pH Meter with SE 101 pH/Pt 1000 combination electrode, (combination pH/Pt 1000 electrode, plastic, 110 mm)	766-SET A
	Set B	766 Laboratory pH Meter with SE 100 pH/Pt 1000 combination electrode, (combination pH/Pt 1000 electrode, glass, 165 mm)	766-SET B
	Options		
	Power supply	115 V AC	363
	pH/Pt 1000 combination electrode	Glass body, length 170 mm	SE 100 N
	pH/Pt 1000 combination electrode	Plastic body, length 120 mm	SE 101 N
	Combination pH electrode	Glass body, length 170 mm	SE 103 N
	Combination pH puncture electrode	Plastic body, length 65 / 25 mm	SE 104 N

Laboratory Meters







■ continued - Product line Laboratory pH meters and combination pH electrodes

			Order No.
	pH/Pt 1000-combination electrode	(Glass body, ground diaphragm, length 165 mm)	SE 106 N

■ Product line Accessories

			Order No.
	Attachable stand	Besides the immersion stirrer, the attachable stand can hold three sensors of any kind. The adjustable stops prevent damage of sensor and beaker glass. Time-consuming adjustment during sample change has been eliminated. An integrated cable duct does away with the "spaghetti cables" on your benchtop. For immersion stirrer and three sensors. Fixed directly to the meter.	ZU 6954
	Immersion stirrer	The immersion stirrer reduces electrode response time for measurement and calibration. Precision measurements to DIN 19268 even require stirring. To prevent splattering of test liquid, the stirrer automatically stops as the carriage moves up. The stirrer is supplied via the ZU 6956 plug-in power pack.	ZU 6955
	Plug-in power pack	For immersion stirrer	ZU 6956

■ Product line Sensors and buffer solutions

		Order No.
	Pt 1000 temperature probe	For fast response temperature measurements: Monel 2.4360, -10 ... +100 °C), accuracy class A to IEC 751
	Pt 1000 temperature probe	For fast response temperature measurements, with tilted tip for puncture measurements in semi-solid substances: Monel 2.4360, -10 ... 100 °C, pH 0 ... 14, accuracy class A to IEC 751
	Calibration buffer set	With Knick technical buffer solutions, 250 ml each of pH 4.01, pH 7.00, pH 9.21, and KCl solution
	Calibration buffer set	With standard buffer solutions to DIN 19266 and NIST (NBS), 250 ml each of pH 4, pH 7, and KCl solution
	KCl solution	250 ml bottle
	Knick technical buffers	pH 4.01 (set with 30 bags for one calibration each)
		pH 7.00 (set with 30 bags for one calibration each)
		pH 9.21 (set with 30 bags for one calibration each)
		pH 4.01 (1000 ml)
		pH 7.00 (1000 ml)
		pH 9.21 (1000 ml)